



smart solutions for smart classrooms





Team up - Ideal for Smart Classrooms

Team up - a fine blend of functionality and good design, **Team up** is a smart solution for modern Lecture halls / classrooms. It features a unique wire management provision for individual user which is elegantly integrated on the legs. The unique swivel plate joinery between table tops allows for straight as well as curvilinear classroom layouts.



Highlights

- Sleek and Sturdy construction
- Suitable for both straight and curvilinear layouts
- In-built power & Data provision makes **Team up** ideal for "Smart Classroom"
- Uniquely designed standardized & Interchangeable table tops for quick installation
- Elegant leg design is enhanced by the ergonomically designed shoe caps.

Ergonomic design

The well rounded table top corners and the rounded legs make **Team up** a safe and ergonomic product. The grouted legs are capped with an aesthetically designed shoe that has no sharp corners for additional user safety.

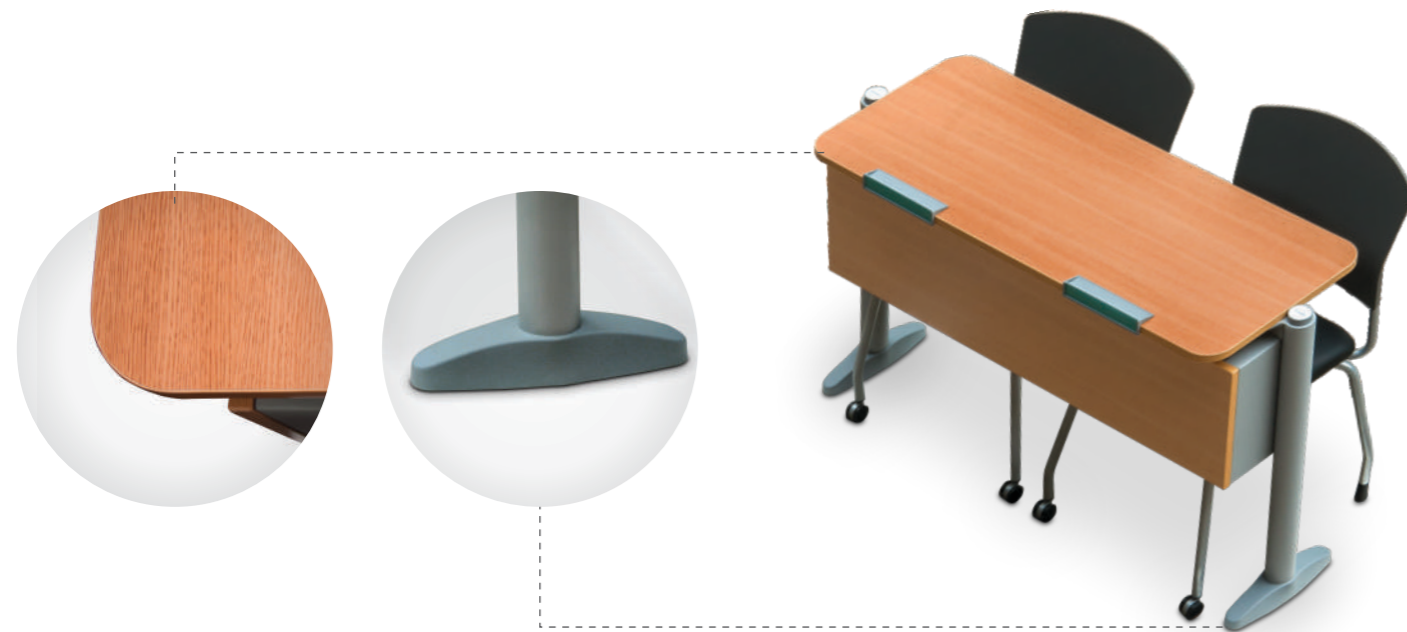

Smart Functionality

- Data and Power outlets with independent controls for each seat
- Ergonomic utility tray that's handy and doesn't compromise leg room
- Wires run through the hollow legs right down to the floor - enables clean wire management

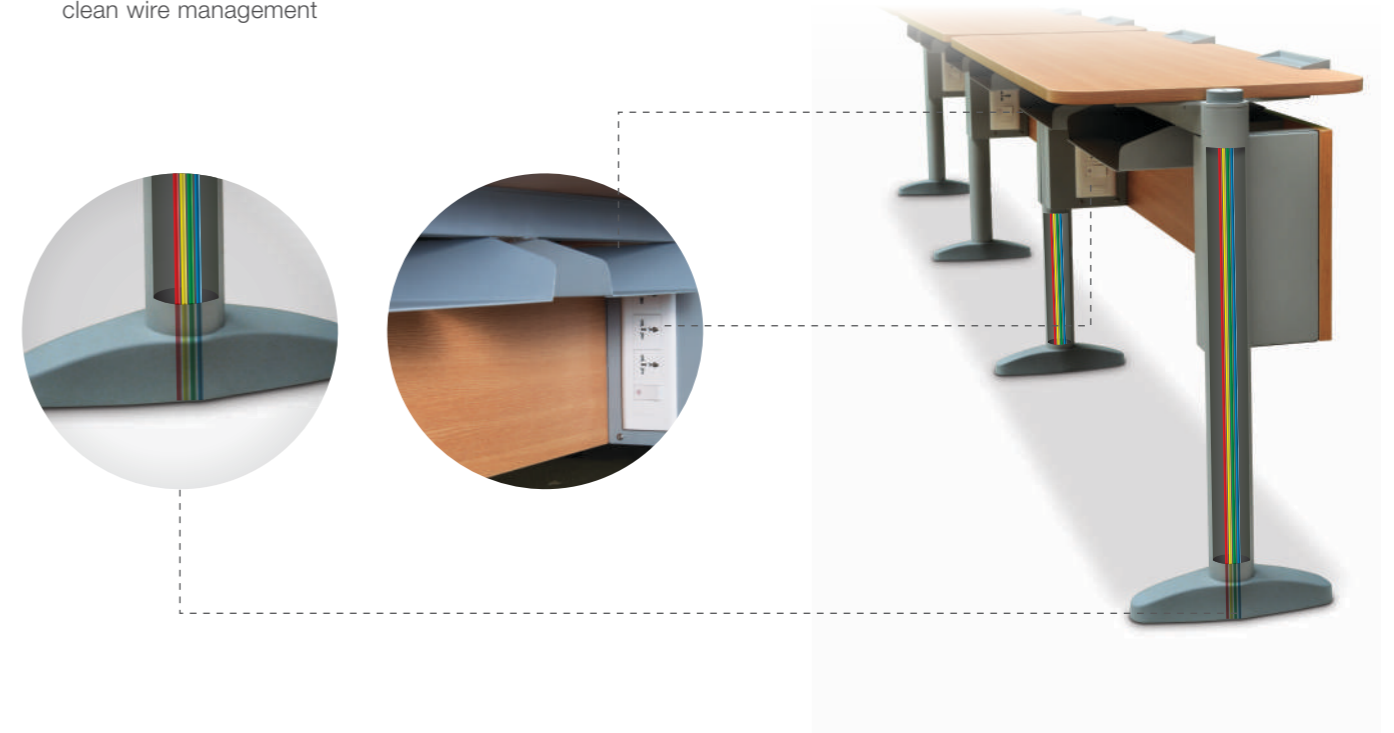

Robust construction

Team up comes with inbuilt provision for grouting with anchor fasteners, ensuring stable mounting & product longevity. A specially designed injection moulded plastic shoe covers the anchor fasteners giving an elegant clutter-free look.





Team up - Ideal for Smart Classrooms

Team up - a fine blend of functionality and good design, **Team up** is a smart solution for modern Lecture halls / classrooms. It features a unique wire management provision for individual user which is elegantly integrated on the legs. The unique swivel plate joinery between table tops allows for straight as well as curvilinear classroom layouts.

Highlights

- Sleek and Sturdy construction
- Suitable for both straight and curvilinear layouts
- In-built power & Data provision makes **Team up** ideal for "Smart Classroom"
- Uniquely designed standardized & Interchangeable table tops for quick installation
- Elegant leg design is enhanced by the ergonomically designed shoe caps.



Ergonomic design

The well rounded table top corners and the rounded legs make **Team up** a safe and ergonomic product. The grouted legs are capped with an aesthetically designed shoe that has no sharp corners for additional user safety.

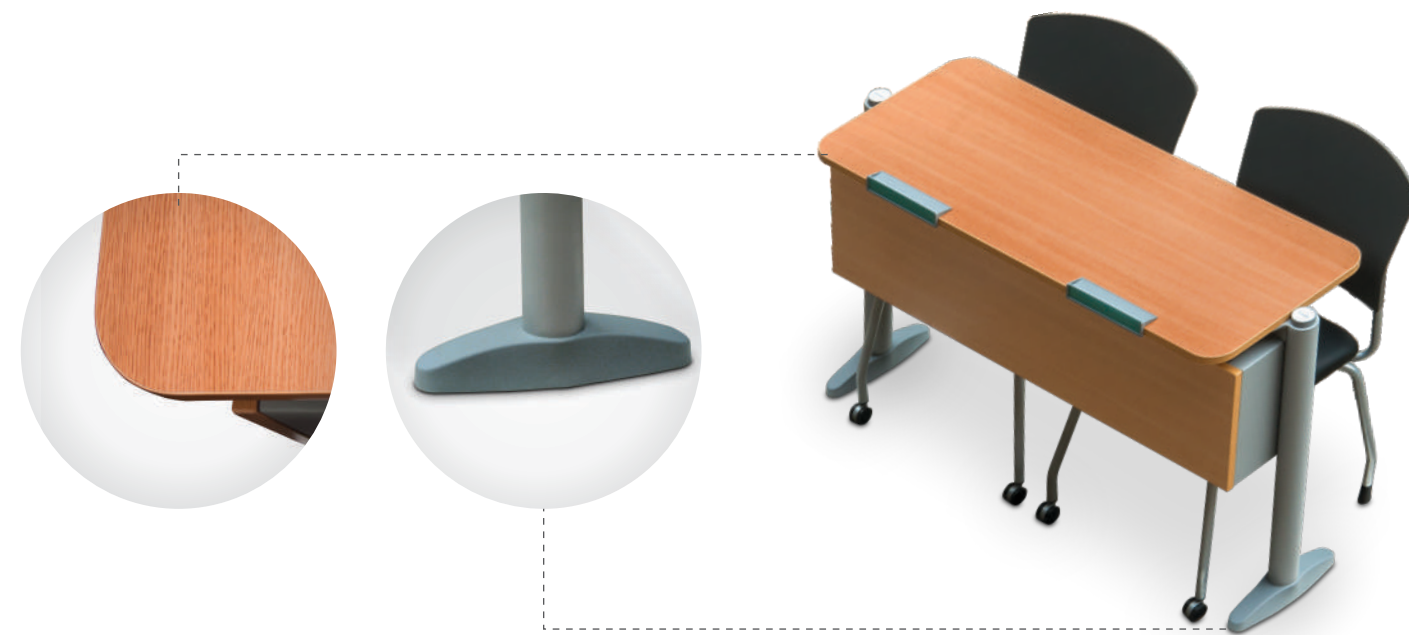

Intelligent Design

Team up is suitable for varied applications like stepped / flat floorings as well as straight / curvilinear layouts. It has been thoughtfully designed for modularity as all table tops are of identical size and shape for any particular layout. This makes it a versatile solution as the table tops can be interchanged and makes installations easier and quicker.

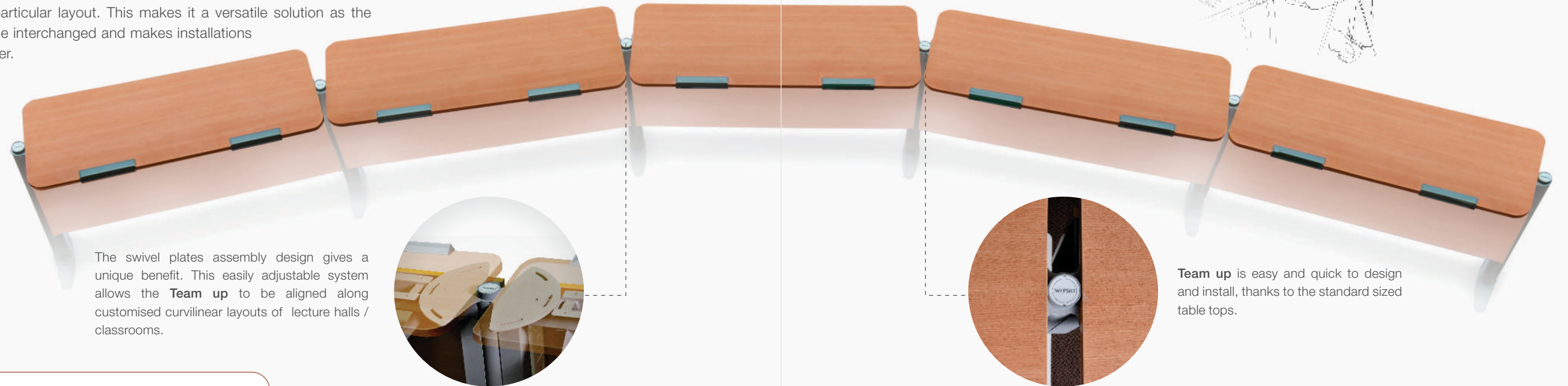

The swivel plates assembly design gives a unique benefit. This easily adjustable system allows the **Team up** to be aligned along customised curvilinear layouts of lecture halls / classrooms.

Team up is easy and quick to design and install, thanks to the standard sized table tops.

Wipro's range of training chairs are a perfect complement to **Team Up**.



Pause

Annexe

Transit



Configurations & Dimensions

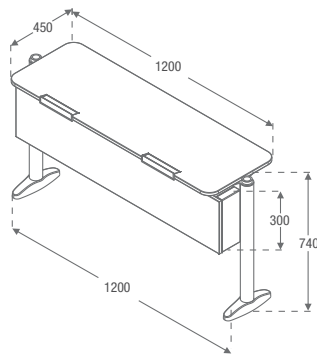

Available in two sizes : 1200 / 1350

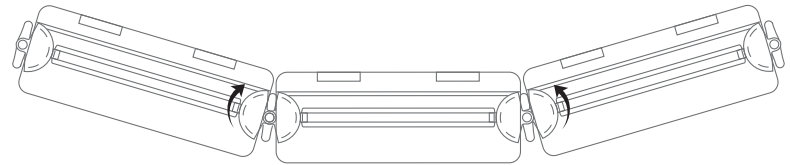

Tables can be swiveled for curvilinear arrangements



Tables can be installed side by side for straight arrangements

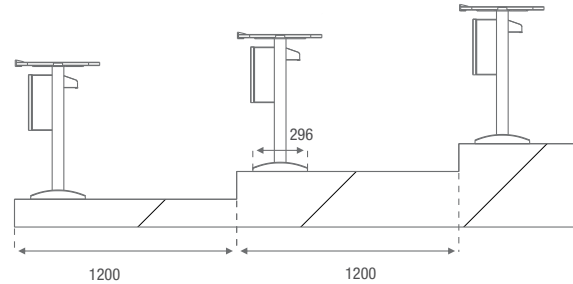
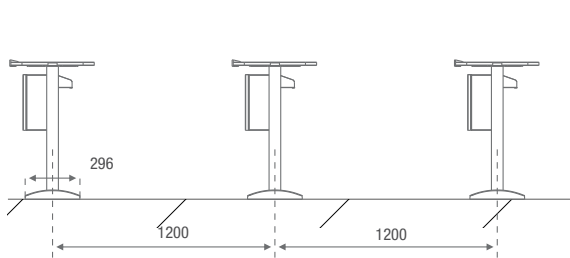

Specifications

Table Size	: 1200/1350 mm (L) x 450mm (W) x 740mm (H)
Under structure	: All metal parts are powder coated for long service life
Leg	: Round 63mm Dia x 2mm Thk MS Pipe welded with 3mm Thick CRCA Brackets in bottom to grout it to the floor
Leg Top Plate	: Made of 300mm dia x 5mm thick HRCA to hold the table with swivel provision to accommodate straight & curve profile of the layout
Stiffener / Wire Carrier	: Size of 54 x 50 x 1.6mm Thk CRCA "U" section with 1.6mm thick CRCA "C" Channel welded on both sides of the tie to connect with Legs
Table Top	: Made up of 18mm Thick pre-laminated particle board with 2mm thick PVC edge banding all around with rounded edge, meeting safety and the ergonomic requirements
Modesty	: 18mm Thick Pre-lam with 2mm thick PVC Edge banding
Book Shelf	: Made of 1.00mm Thk CRCA powder coated fixed below the worktop
Power Management	: Provision to accommodate up to 8 switch plate modules



Wipro Enterprises Private Limited - **Furniture Business**

Doddakannelli, Sarjapur Road, Bangalore - 560035

Customer care number: 1800 425 1969

Write to us at vibrant.solutions@wipro.com

Ahmedabad: +91 79 40073546, Bangalore: +91 80 40541237, Chandigarh: +91 172 2661355, Chennai: +91 9500088426

Cochin: +91 9387881504, Hyderabad: +91 40 27176082, Indore: +91 731 4023486, Kolkata: +91 33 22829268

Mumbai: +91 7406002777, Nagpur: +91 712 2233562, New Delhi: +91 11 41708122, Pune: +91 20 25535081

Vadodara: +91 8758856507