

levitate™

elevate the working comfort

Designed by Michael Foley



WIPRO FURNITURE



CONNECTING THE DOTS

BRIDGING THE GAP

Inspired by Wipro's philosophy and values,

the idea of

CONNECTING THE DOTS & CONNECTING

INDIVIDUAL ideas,

insights and

innovation.

Wipro Furniture and the renowned designer Michael Foley present Levitate – a range of furniture designed to elevate the working comfort, express culture and foster belonging. Addressing the future agile work environments in India and alternate workspaces - beyond workplaces like an industrial setup or a home; Levitate elements can be arranged in configurations and that can evolve as needs change. Layers of colour & material create visual consistency and enhance the flow of movement from an individual to group activities, and from private to shared spaces. This new furniture range bridges the gap by innovating the way furniture units can come together to create interesting formations triggering maximised collaboration.



as an initiative under the 'Atmanirbhar Bharat Abhiyan' or 'Self-Reliant India Mission', this product is completely designed & manufactured in India

Michael Foley - a Bangalore-based designer and NID alumnus established Foley Designs in 2006, prompted by the universality of design.

Collaborating with Wipro Furniture, Michael glances through a periscope of consumer and market insights, to create viable, design-led solutions.

As we learn to work and adapt in a Covid world, some of the more immediate suggestions include reconfiguring desks to reduce face-to-face orientation. It also suggests using more open spaces for meetings of more than five people as well as leveraging flexible furniture with movable whiteboards and screens to create boundaries.

Levitate - by Michael Foley, evolves into effective and feasible reality that creates meaningful engagement.

“ Our working habits are going through a creative transformation, expanding the way we adapt and interact with spaces. This is a promising perspective change and, hopefully, will transform the way we work in the future. ”



Michael Foley



REDEFINING THE CHANGING WORKSPACE

With the fast-paced change in workstyles and working habits, organisations are progressing towards creating a greater balance between conventional work practices, flexibility and comfort. New collaborative solutions are largely driven by the need for innovation and speed of decision making.

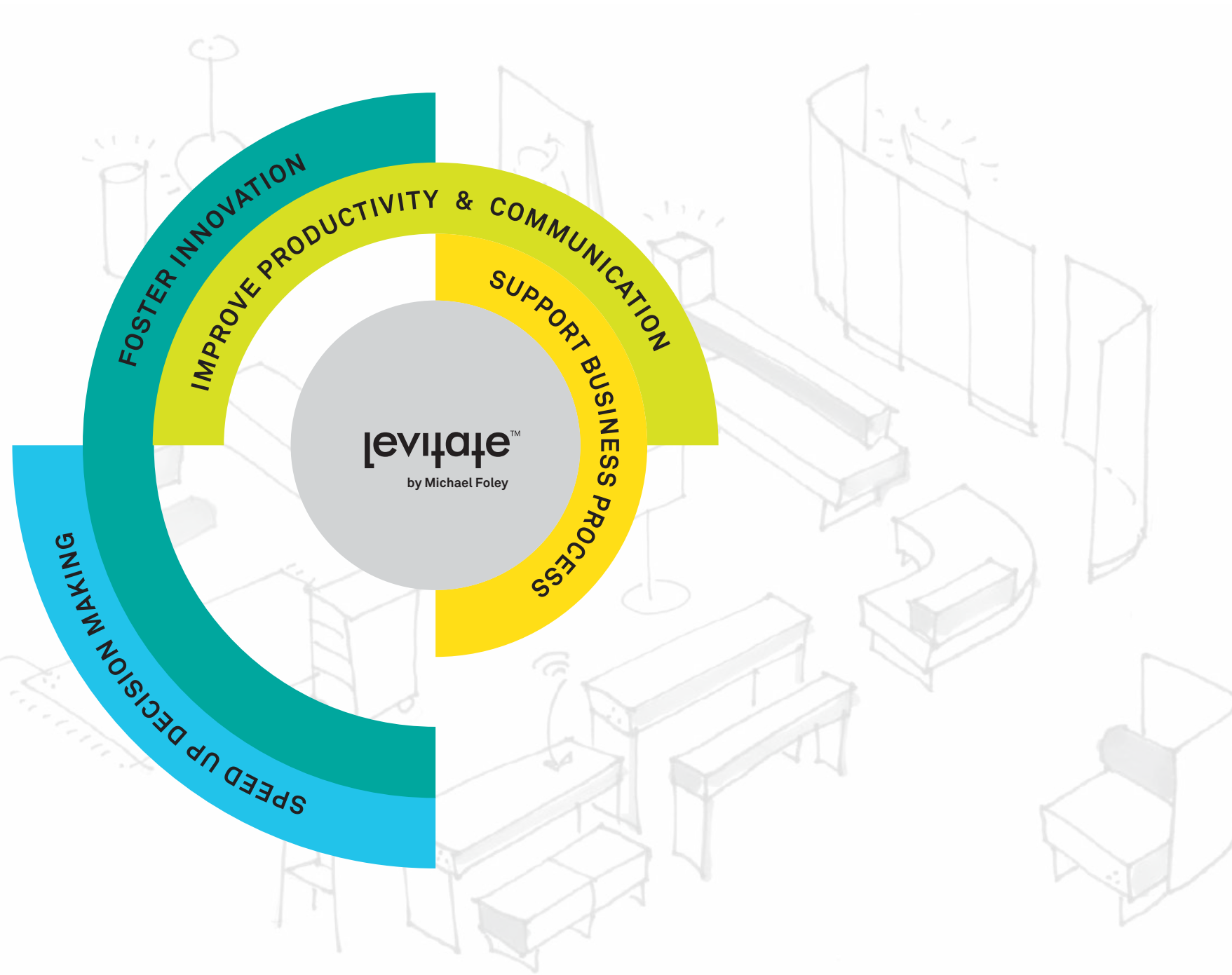
As we work beyond workplaces, collaborative work is more dependent on technology than ever and has changed the way we work. Devices have become indispensable, bringing in connectivity and accessibility anywhere.



While we witness this paradigm shift, there is an evolution away from desks and cubicles to far more agile comfortable environments. The rise of alternate type of workspaces that are more engaging, less regimental and more resimercial, redefines the real need for smart, functional, flexible and collaborative 'interaction furniture', which is the design thinking approach brought to you through **Levitate**.

Levitate increases productivity and proficiency by extending the freedom to work and largely drive the need for innovation and speed of decision making.

A collective of thoughtfully designed furniture that can quickly transform an open office plan into an agile and productive space, creating a comprehensive office environment.

Easily movable furniture elements to create reconfigurable functional spaces that address 5 key workstyles from dedicated work, mentoring / learning, brainstorming, team support to impromptu meetings.

DEDICATED WORK

breaking the archetypal 9 to 5 desk job

the new prerequisite

is **isolation**

is **quietness**

your space

your privacy

your mind is occupied

detach yourself

from the crowd

your focus

your own

personal bubble

in a work environment

wired & connected

in an **easy movable**

reconfigurable array



DEDICATED WORK

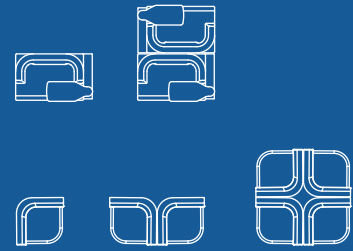

1



2



3

1. Dedicated sofa (small) with Beach Wood legs for stability & durability
2. Back-to-back arrangement of dedicated sofas (small) with built-in USB port
3. Cluster of four dedicated sofas (small)
4. Dedicated sofa (large) with tablet ++
5. Coffee table with reverse chamfered wooden top and sturdy metal base
6. Easily portable light-weight yet sturdy personal table with tubular metal structure
7. Rectangular center table with writable glass top fitted in wooden construction

FEATURES

- A. Easy to clean, washable fabric
- B. Built-in 3-pin socket* for convenience of power supply
- C. Rotating working and writing tablet

**Available only with dedicated sofa (large)*



4



5



6



7

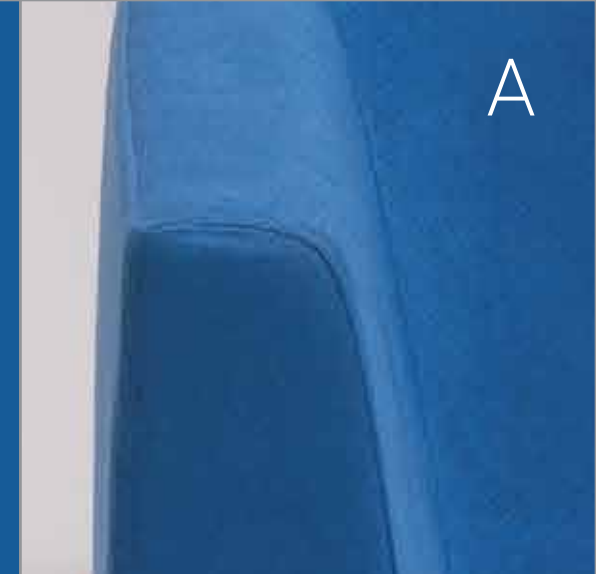

A



B

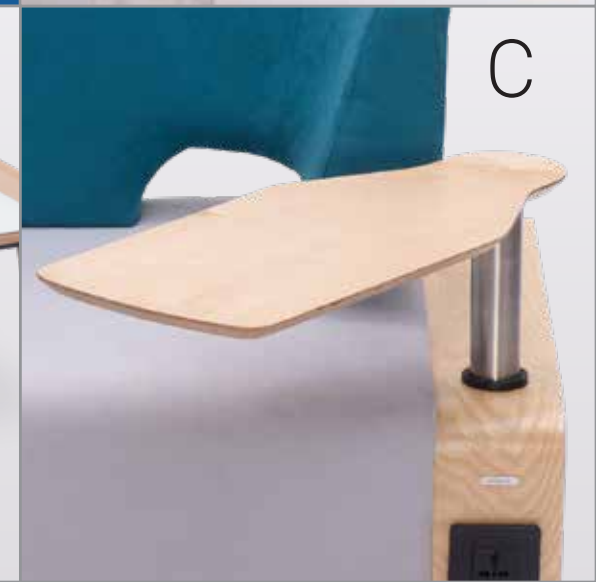

C

MENTORING / LEARNING

cohesive collaboration.
coffee & conversations



me, we, free zones
for exchanging thoughts
to solve the complex and
generate the big idea for
motivating meaningful
collaborative team
discussions by
maintaining social
distancing with
non-obstructive
structural space divisions
like an **ergonomic working**
ledge, movable digital
display unit and **center**
table with writable glass
top to doodle making it an
ideal **space to work,**
gather or relax

seen are two-seater sofas, portable digital display unit (with 42" tv mounted) and rectangular center table





1

MENTORING / LEARNING

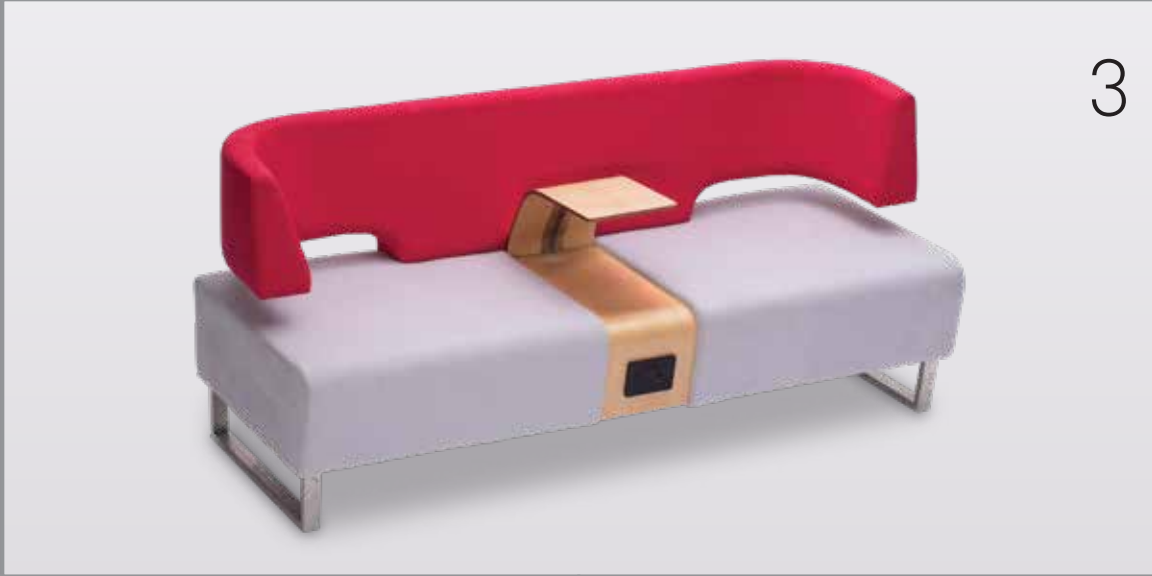
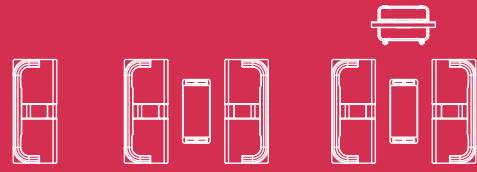

3

1. Designer two-seater sofa
2. Spacious seating
3. Simple design with stainless steel legs that add to the aesthetics
- ++
4. Coffee table with reverse chamfered wooden top and sturdy metal base
5. Portable digital display unit with sturdy castors and built-in pen/marker tray, 3-pin socket, USB port and HDMI cable port
6. Rectangular center table with writable glass top fitted in wooden construction

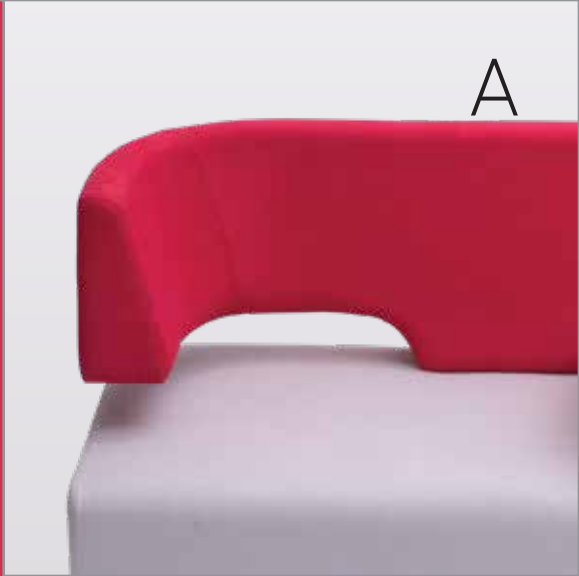

A



2

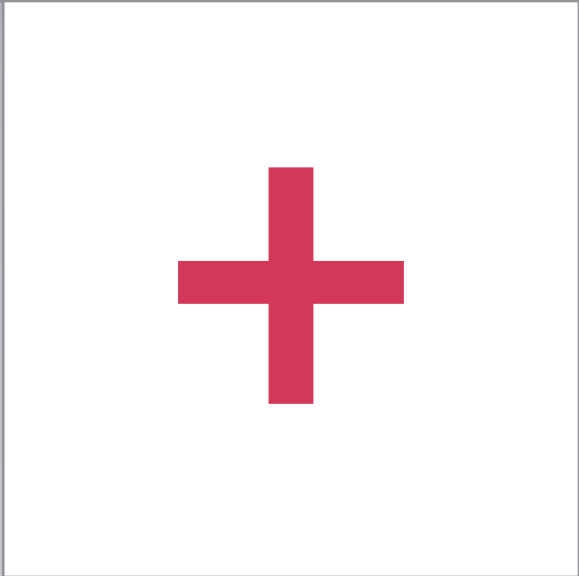

5

FEATURES

- A. Angular seating module for seating comfort and easy communication
- Easy to clean fabric
- B. Integrated ledge along with built-in 3-pin socket and USB port
- C. Door on the back side of the digital display unit that gives access to additional storage space and electrical connections



B



4



6



C

BRAINSTORMING

out-of-the-box thinking
when you don't sit in a box



the decreasing demand for closed door meetings, formal conference rooms increased the imposition for more **interactive brainstorming** areas. a new workstyle that can happen anywhere. ideal for **fluid interactions** and those **spontaneous conversations interweaving zones & tasks** and its functionality. counter/bar height supports team meetings, project-based activity and **casual collaboration** or **safe distance socialising**.





1

BRAINSTORMING

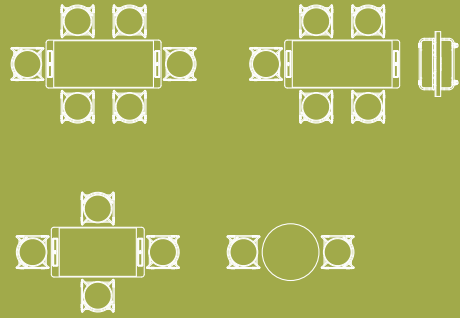

4

1. 6-seater high table with writable glass top, pen/marker tray and wooden legs made of durable solid Ashwood
2. 4-seater high table with laminate top and wooden legs
- ++
3. High stool with multi-layer multi-density PU high resilience foam to maintain firmness of the seat ensuring that cushion does not flatten over the years
4. Sturdy, portable digital display unit with pen/marker tray, built-in 3-pin socket, USB port and HDMI cable port
5. Round table for quick meet-ups

FEATURES

- A. Wooden table top with metal branding
- B. Metal understructure and reverse chamfered wooden table top
- C. Built-in 3-pin socket, switch, USB port and HDMI cable port*

**Available only with Laminate finish*



A



B



2



3



5

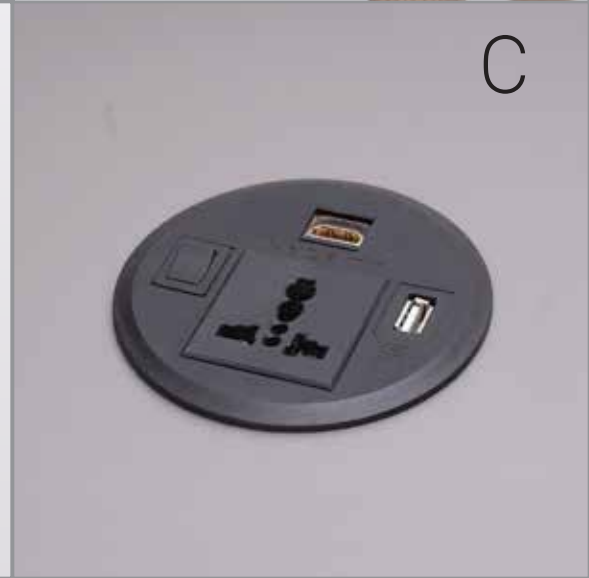

C

TEAM SUPPORT

residential design is on the rise and here to stay. creating workplaces with a residential sensibility in mind with comfort as a key consideration.

a place for **team meets**, a place to **unwind & relax**,

a place for a **quick regroup**, or a place to **simply get work done**

incorporating tactile textures, materials and add-ons that evoke a sense of warmth and familiarity create

human-centric spaces

people say, 'i think best when at home'
so we brought home to the office



1



2

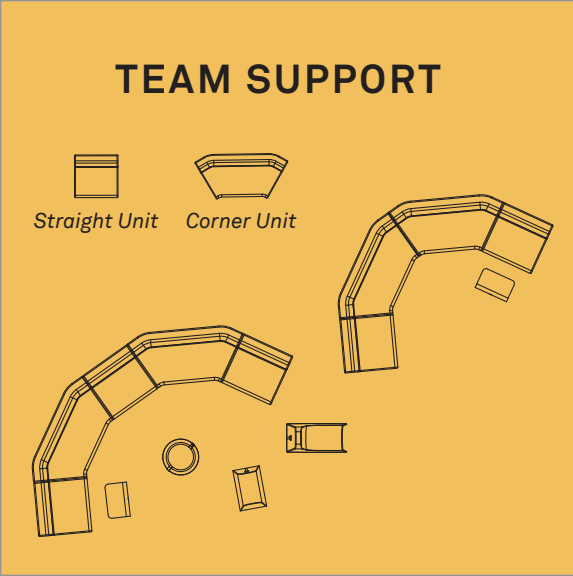

TEAM SUPPORT

Straight Unit Corner Unit

6



A

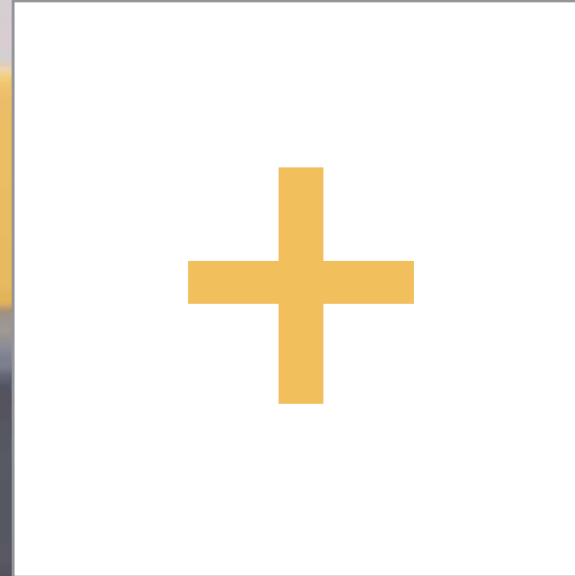
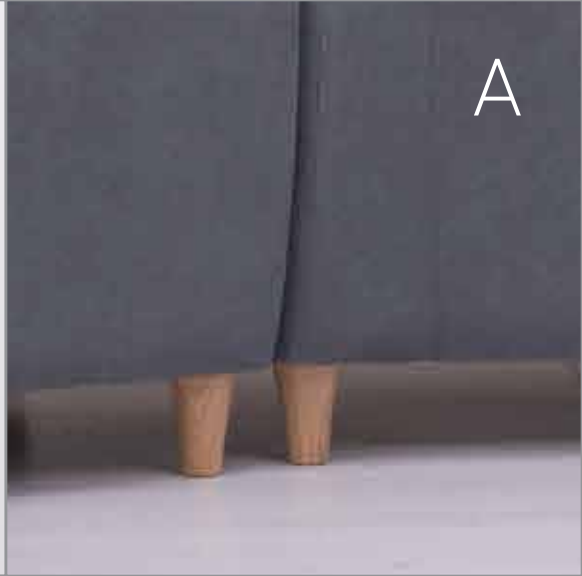

4



1. Spacious seating for multiple team members for bonding activities
2. Ease of communication
- ++
3. Light-weight yet sturdy personal table with tubular metal structure
4. Rectangular center table with writable glass top fitted in wooden construction
5. Coffee table with reverse chamfered wooden top and sturdy metal base
6. Round pouffe enabling a complete 360° rotation of the seating area, having a leather handle for easy movement

B

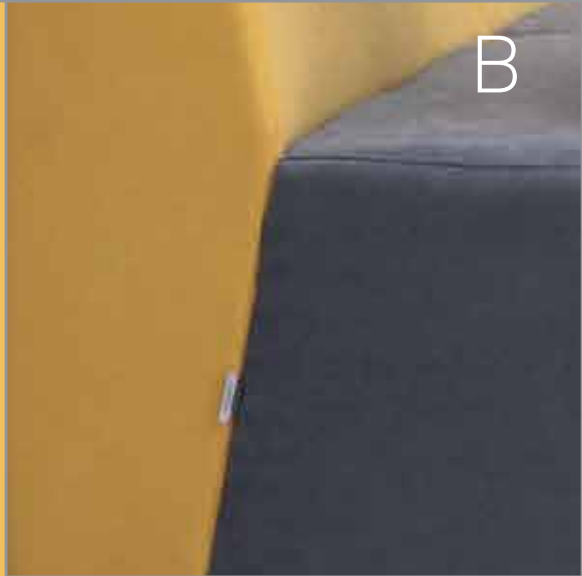

3

5



FEATURES

- A. Detachable system for comfortable logistics and easy installation
Wooden legs provide stability
- B. Easy to clean fabric
Angled fitting of seating and backrest with integrated metal branding
- C. Built-in USB port*

*Available only with Straight Unit

C

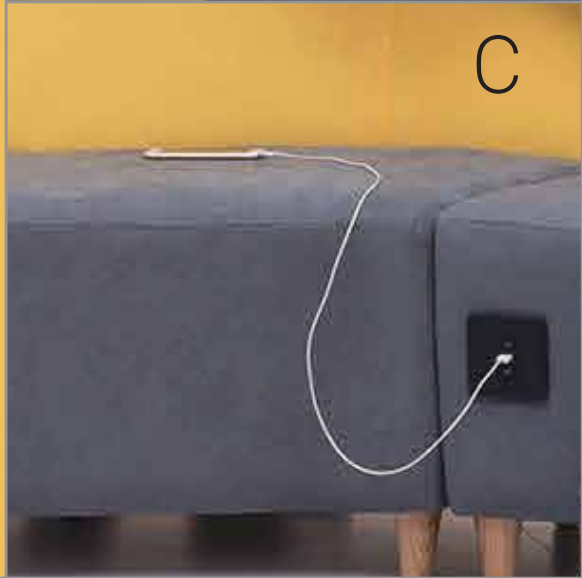

IMPROMPTU MEET

mobilizing impromptu innovations



nothing is fixed in life,
so why should your
furniture be fixed?

creative thinking can begin
in one space and can be
refined or expanded
elsewhere

move yourself and the
furniture around and
share an **idea**

share a **thought**

share **scribbles & notes**
on the A-board or movable
A-board stools

share it while sitting

share it standing or
comfortably perched

light-weight, stackable
and movable



1

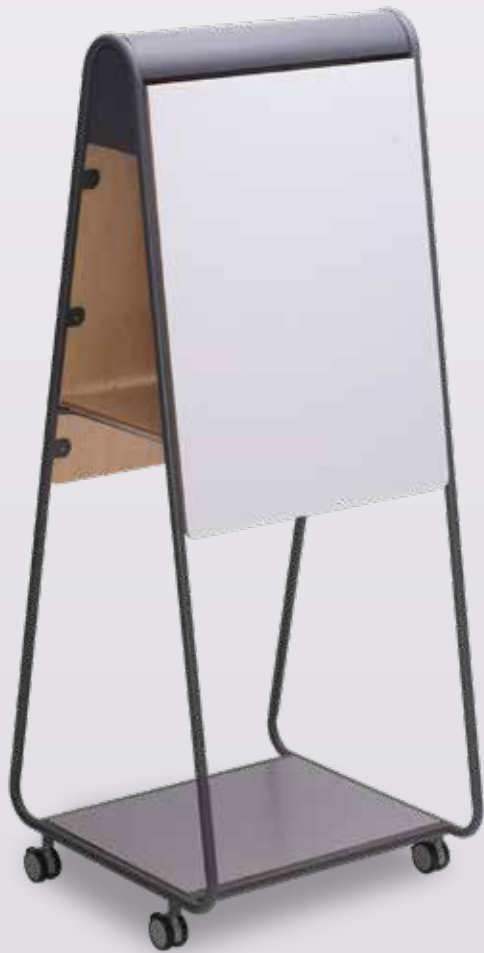

3



5



7



IMPROMPTU MEET

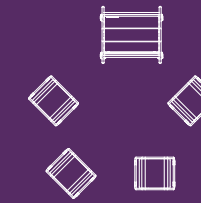

A

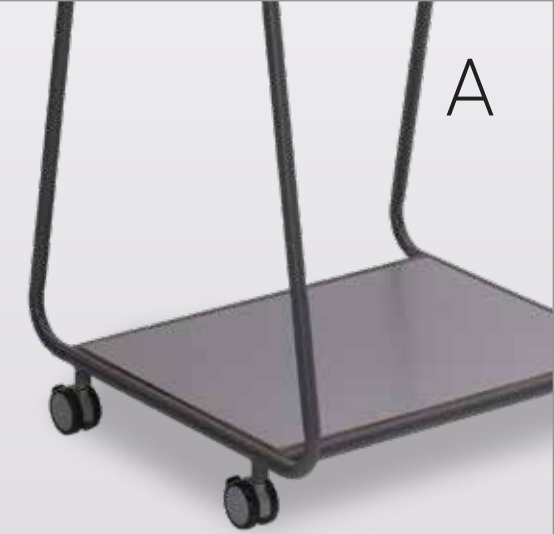

4



1. Easily portable A-Board with white boards on both the sides. Easy to rotate and use the other side, if needed
 2. A-Board stool with tubular metal construction and easy to clean fabric
 3. Stacked A-Board stools
 4. Space saving A-Board with the stools stacked inside
- ++
5. Paper-roll fitted inside for notes to take-away after the discussion and tray to keep pen/markers
 6. Light-weight personal table
 7. Coffee table with reverse chamfered wooden top and sturdy metal base

FEATURES

- A. Sturdy base with tubular metal construction and lockable wheels
- B. Compact A-Board stools arranged as per number of members in the discussion with paper pulled out for writing purpose

2



6



B



extra happiness can be added
whenever, however & wherever



seen are saddle pouffes (large), round pouffes with a coffee table



1



2



5



3



4

+

1. Saddle pouffe (large) enabling to-and-fro rocking movement for a joyful seating experience
2. Round pouffe enabling a complete 360° rotation of the seating area for a playful feeling
3. Saddle pouffe (small) enabling to-and-fro rocking movement of the seating area
4. Curved seat for comfortable seating with easy to clean fabric and in-built leather handle
5. Wipro branded leather handle for easy portability
6. Wall ledge with built-in 3-pin socket and USB port



6

COMPLETE OFFERINGS



the open office was aimed at improving collaboration and proficiency among employees. by the turn of the century, and after a few decades of cubicles, the open office became the norm. different types of furniture, which demarcated different spaces of work, was a distinct feature of the open office floor plan.

Levitate - by Michael Foley serves the purpose of being in the individual zones yet being into working environment mentally.

MATERIALS & FINISHES

Fabric – Warwick Australia

Dolly

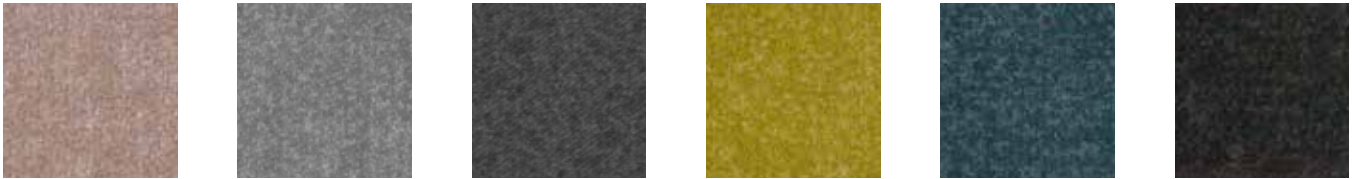

Ash Cement Charcoal Citron Denim Ebony



Flame Magenta Mink Peacock

Ashcroft

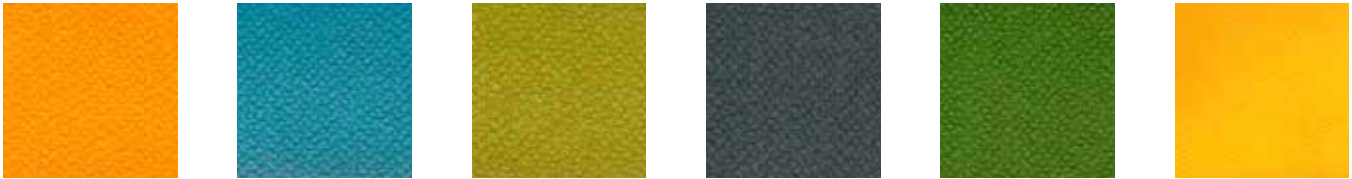

Canary Cloud Grass Gunmetal Kiwi Lemon

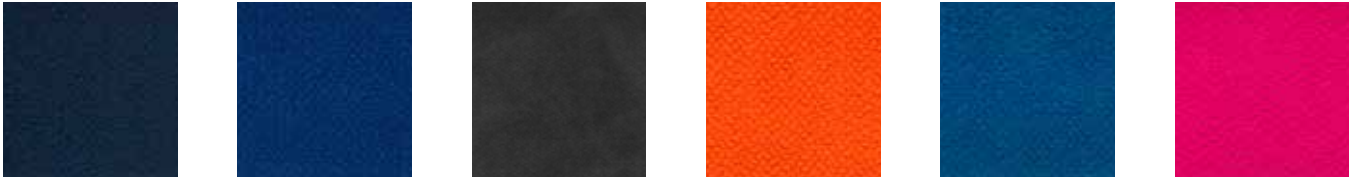

Navy Ocean Onyx Orange Pacific Pink



Purple Red Scarlet Silver Teal Turquoise

Powder Coating Finishes



RAL 7045 RAL 9023 RAL 7039

Wood Finishes



Natural Oak Golden oak Dark Oak

About Seating Products

Upholstery Fabric (Warwick) comes with Fire Retardant Treatment, Spot Cleaning Feature, special treatment to protect from insects & pests

Fabrics also come with features such as high abrasion resistance, colour-fastness to light, stain and pilling resistance

Upholstery available both in monochromatic or contrasting colours for a personalised aesthetic

Designed to create resimercial influence with uniquely curved backrests and cushioning that invites relaxation

Concealed wiring for power inputs to the electrical accessory to ensure aesthetics for all seating products

Combination of imported Pine wood and high grade Merino Ply used for internal construction to ensure long life

SS shaped metal springs and elastic belts made of synthetic rubber to ensure long life suspension of seat

Multi-layer multi-density PU HR foam to maintain firmness to ensure cushion will not flatten over usage

materials and finishes chosen are for the ease of coordination and use.

products like A-board, digital display stand, personal table and high stool follow a **metal**

tubular construction.

each element works in concert with other pieces to **integrate seamlessly**

into any kind of workplace.

the items can be **configured and re-configured to suit the changing needs.**

easily and instantly **power up your devices** with **Levitato's** built-in power.

TECHNICAL SPEC.S

Statement of Line

Dedicated Sofa (Small)
760 L x 760 D x 790 H

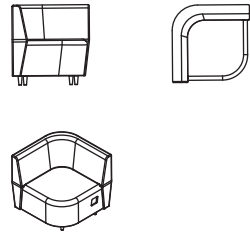

Center Table
1250 L x 540 D x 480 H

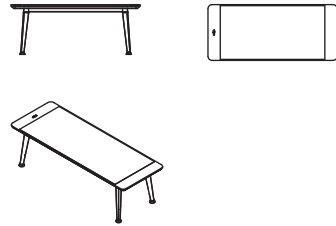

High Stool
Ø 430 x 770 H



A-Board
720 L x 750 D x 1900 H

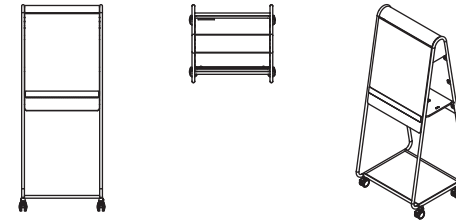

Round Pouffe
Ø 500 x 450 H



Coffee Table
Ø 600 x 480 H



Dedicated Sofa (Large) with Tablet
1090 L x 660 D x 790 H

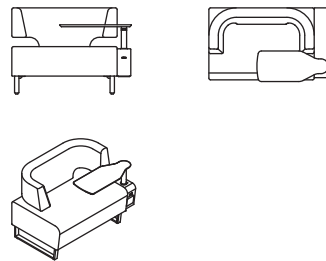

High Table (6 Seater)
1800 L x 750 D x 1030 H

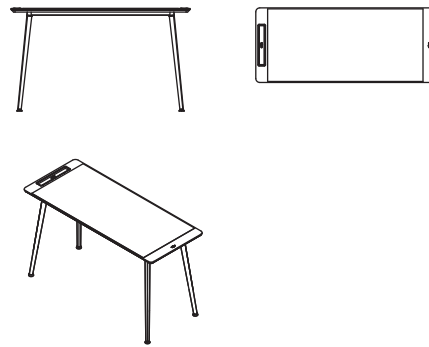

Digital Display Unit*
775 W x 580 D x 1800 H

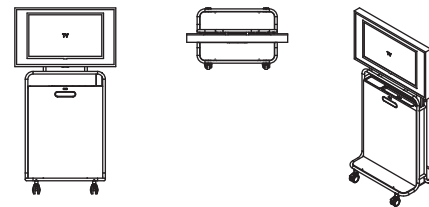

* Suitable for 42" / 44" tv

A-Board Stool
510 L x 410 D x 480 H



Saddle Pouffe (Large)
830 L x 400 W x 825 H



Personal Table
550 L x 350 D x 640 H

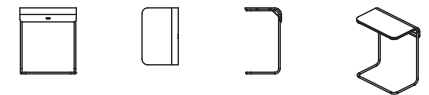

Two Seater Sofa
1740 L x 660 D x 790 H

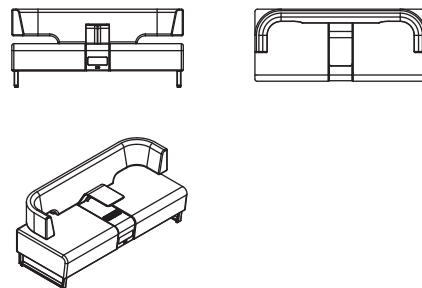

High Table (4 Seater)
1400 L x 750 D x 1030 H

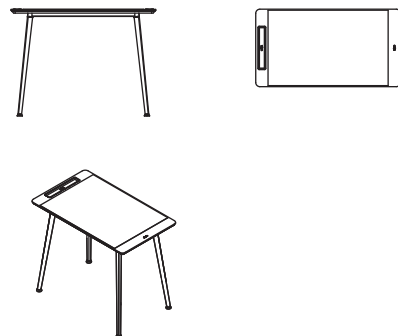

Round Table
Ø 750 x 1028 H

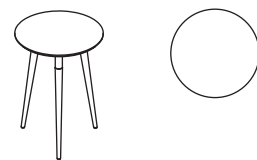

Lounge System
4400 L x 660 D x 790 H

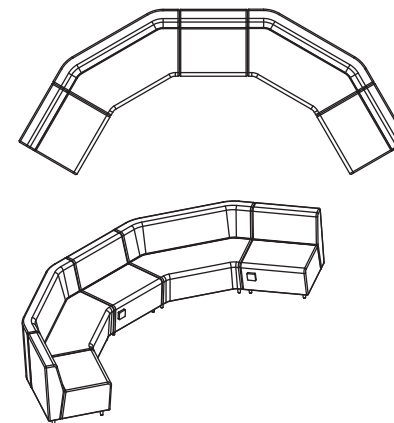

Saddle Pouffe (Small)
650 L x 638 W x 450 H

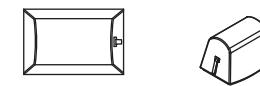

Wall Ledge
900 L x 385 D x 440 H





Wipro Enterprises (P) Limited - **Furniture Business**,
Block-C, 3rd Floor, Doddakannelli, Sarjapur Road, Bangalore - 560 035.
Tel.: 080-28440011. Fax: 080-28440057. email: vibrant.solutions@wipro.com

Branch Offices:

Ahmedabad: +91 99789 94383, Hyderabad: +91 98331 66641/+91 95000 86336, New Delhi: +91 99000 13655,
Bangalore: +91 85110 01015, Indore: +91 98907 89787, Pune: +91 98228 88363, Chandigarh: +91 99000 13655,
Kolkata: +91 95601 93973, Chennai: +91 99622 90818, Mumbai: +91 74060 02777, Cochin: +91 97456 09399,
Nagpur: +91 98907 89787, Vadodara: +91 99746 20001, Trivandrum/Madurai: +91 98470 51441

www.wiprofurniture.in

*Innovation and Design is a way of life at Wipro.
We reserve the right to modify the product without prior intimation.*

